

PROTECT PSC – Programmable Modular Safety System Overview 08

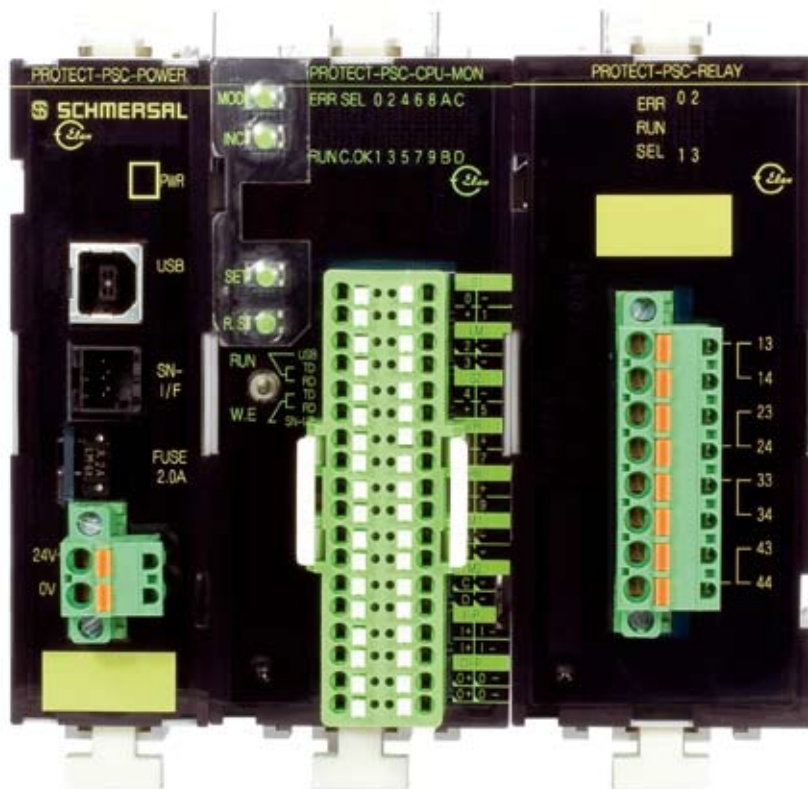

PROTECT PSC – Programm

The PROTECT PSC programmable modular safety control system is primarily designed for use in modern production systems or in complex individual machines.

PROTECT PSC is suitable both for the safe evaluation and linking of several safety-oriented signals such as emergency stop control equipment, guard monitoring, safety light curtains (AOPDs) or safety sensors from the Schmersal CSS, MZM or AZM200 ranges.

A significant advantage of the PROTECT PSC lies in its modular and therefore extremely flexible construction. This enables the user to achieve an optimal solution for the respective task from the point of view of costs without leaving unnecessary numbers of inputs or outputs unused. In addition the very high packaging density of connecting terminals helps to save space in the switch cabinet.

PROTECT PSC enables applications to be realised in control category 4 to EN 954-1, Performance Level "e" to EN 13849-1 or SIL 3 to IEC 61508.

As a special feature the PROTECT PSC also offers the possibility of carrying out (non safe) signal processing under operating conditions in addition to safety-oriented signal processing.

If programming is to be completely eliminated, a safe zone section shut-down can be achieved with the PROTECT PSC, similar to a system of safety relay modules, determined only by the sequence of modules on the DIN rail.

A summary of the most important features:

- Modular design
- Integration of safe signals under operating conditions
- Free programming to IEC 61131 via standard USB interface or
- Signal interlinking via external wiring without programming
- Connection facility for external gateway (Profibus, DeviceNet or CC link)
- Reaction time 22 ms (semi-conductor outputs) or 37 ms (relay outputs)
- Visualisation and status display on module or PC
- Simple DIN rail assembly

Connectable devices (sensor level)

- EMERGENCY-STOP-control units with dry contacts
- Safety switch with dry contacts, ditto interlocking devices (with and without latching), enabling switch or similar.
- Electromagnetic safety switch, e.g. Schmersal-BNS
- Protective devices with non-floating contacts, for example optoelectronic protective devices (AOPDs) or similar.
- Safety sensors from Schmersal CSS range and contact-free interlocking devices from the Schmersal-AZM 2xx range.



able Modular Safety System

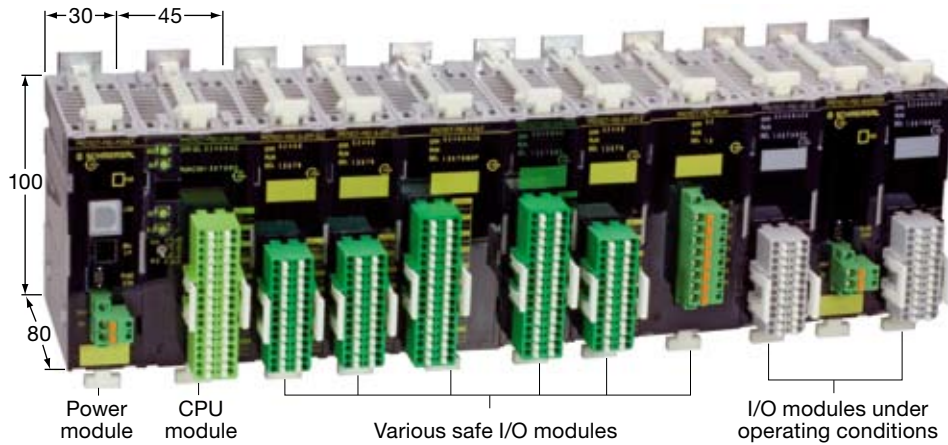

Representation of modular design with dimensioning

Module overview

Module	Number of single channel inputs			Number of single channel inputs			
	Standard signals with dry contacts	Safe Dry ¹	Non-floating ²	Standard signals with dry contacts 0.3 A ^{**}	Safe Transistor		Relay 4 A ^{**}
					0.5 A ^{**}	0.3 A ^{**}	
PSC-CPU-MON	-	8	-	-	6	-	-
PSC-SUB-MON	-	8	-	-	6	-	-
PSC-S-STP-E	-	6	-	-	4	-	-
PSC-S-STP-LC	-	2	4	-	4	-	-
PSC-S-STP-ELC	-	4	2	-	4	-	-
PSC-S-Relais	-	-	-	-	-	-	2 x 2
PSC-S-IN-E	-	16	-	-	-	-	-
PSC-S-IN-LC	-	-	16	-	-	-	-
PSC-S-OUT	-	-	-	-	-	16	-
PSC-NS-IN	16	-	-	-	-	-	-
PSC-NS-OUT	-	-	-	16	-	-	-

* The dry or non-floating information refers to the technical properties of the input signals:

- **Dry-contacts input signals**, e.g. from emergency stop control devices, safety switches, interlocking devices, safety solenoid switches and similar.
- **Non-floating input signals**, e.g. PNP outputs from optoelectronic protective devices such as safety light curtains, laser scanners etc. but also from safety sensors from Schmersal CSS or AZM200 ranges.

** Maximum current per output with resistive load.



PROTECT PSC – Programm

In addition to the central unit (Fig. 1), a power supply module (Fig. 2) and various input and output modules (see Table Page 3) form part of the PROTECT PSC system. A minimum configuration consists of a CPU module and a power supply module. The CPU can trigger up to 15 modules so that additional input and output modules can be added at a later date as required and integrated into the complete system with little effort. All modules can be easily assembled on DIN top hat rails and are connected via backplane bus (Fig. 3). This means the user can freely determine the extension stage of the system and therefore also the number of available inputs and outputs – from 8 inputs and 6 outputs in the most simple version to over 250 inputs/outputs when the system is fully extended. In addition the safety controller also offers interfaces to various gateways (Fig. 4) in order to be able to perform a data exchange via Profibus DP, DeviceNet or CC link.

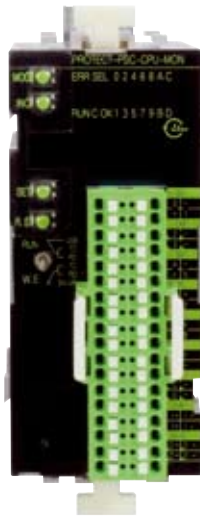

Fig. 1: Central unit PROTECT PSC-CPU-MON



Fig. 2: Power supply module PROTECT PSC-POWER



Fig. 3: Backplane bus



Fig. 4: Gateway

250 inputs/outputs when the system is fully extended.

In addition the safety controller also offers interfaces to various gateways (Fig. 4)

in order to be able to perform a data exchange via Profibus DP, DeviceNet or CC link.

Possible operating mode a) "Hardwired" version

The operation of the PROTECT PSC in Operating Mode 1 is intended for applications in which a zone section shut-down is to be performed **without software programming**. This is, of course, possible in a much simpler and more elegant manner in Mode 3 with free programming.

The application represented in Fig. 5 serves as an explanatory example. A safety request (here emergency-stop contact) to the CPU (master system) switches all outputs of the entire system to the safe state. A safety request (here guard contact) to the SUB-CPU only switches the outputs of the submaster system (Sub-CPU and subsequent input/output modules) to the safe state.

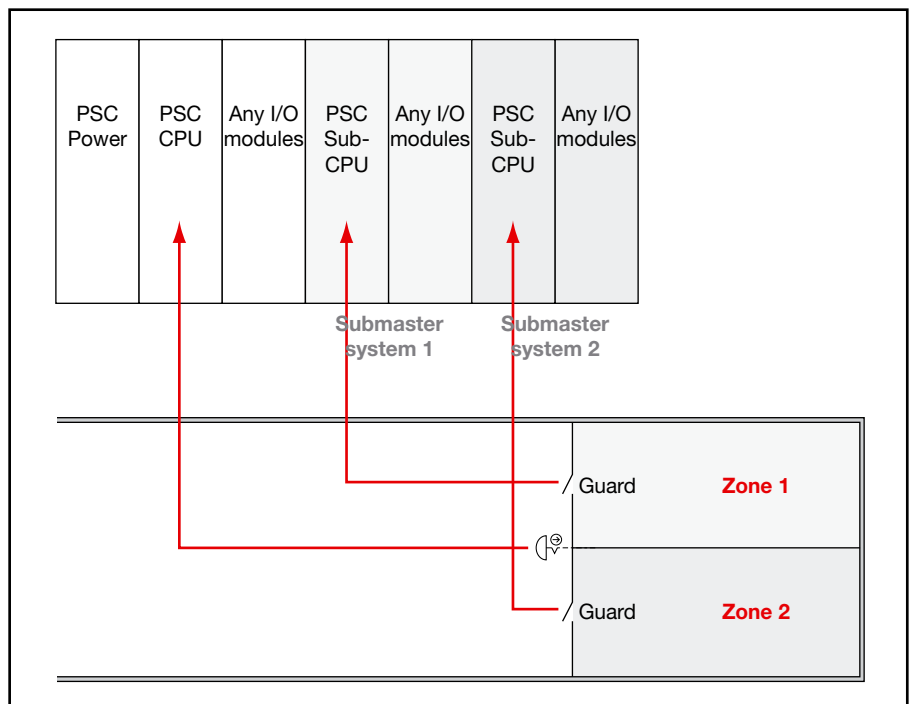

Fig. 5: Example of application

able Modular Safety System

Possible operating mode b) Freely programmable version

This operating mode allows the real capacity and flexibility of PROTECT PSC to be demonstrated. All inputs and outputs of the entire system are assigned via a programming language (ladder) corresponding to IEC 61131. Logic functions, e.g. AND and OR, as well as other dependencies can be freely programmed.

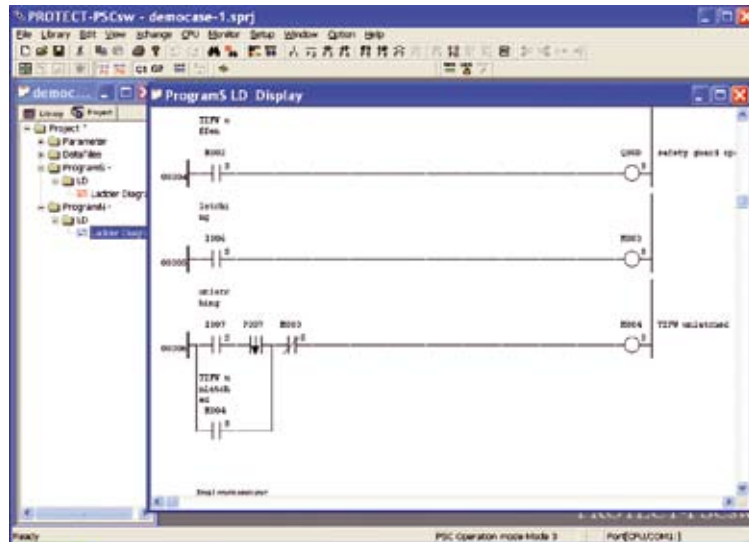
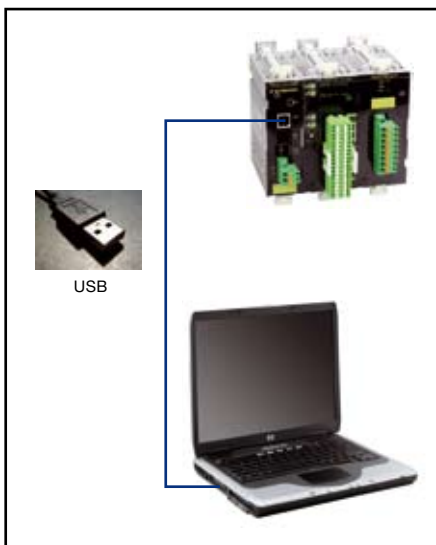

Fig. 6: Programming environment



I/O Module Setup

Group	Slot No.	Alloc Points	Refresh (FrontAddress)	ModuleType SafetyType	Module Name	Fixed FB
Master	0	16	14 (0000)	S Master	Power	
	1	16	10 (0010)	S Normal	CPU MON	
	2	16	10 (0020)	S Normal	S-STPE/LC	
	3	8	04 (0030)	S Normal	RELAY	
	4	16	10 (0038)	S Normal	S-STPLC	
	5	16	16 (0048)	S Normal	S-INIE	
	6	16	16 (0058)	S Normal	S-INILC	
	7	16	16 (0068)	S Normal	S-OUT	
NonSafe	8	16	16 (0400)	N I/O	NS-IN	
	9	16	16 (0410)	N I/O	NS-OUT	
	10	16	16 (0420)	N I/O		
	11	16	16 (0430)	N I/O		
	12	16	16 (0440)	N I/O		
	13	16	16 (0450)	N I/O		
	14	16	16 (0460)	N I/O		
	15	16	16 (0470)	N I/O		

Fig. 7: Configuration of the I/O modules: clear differentiation between safe and operational area

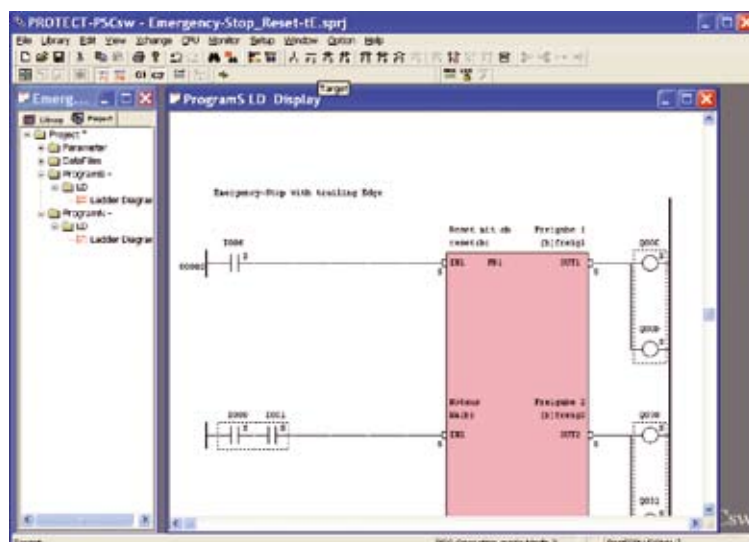

Fig. 8: Free programming to IEC 61131 with the opportunity to incorporate functional blocks into the program. The user is provided with various functional modules in a library. The user also has the possibility of designing own functional modules.

PROTECT PSC – Programm

Diagnosis and visualisation

A fast diagnosis can be achieved via the LED display on the modules or the PC in monitoring mode or by reading out the error reports from the central control unit.



Fig. 9: Clear display on the CPU module of which input and output signals connected

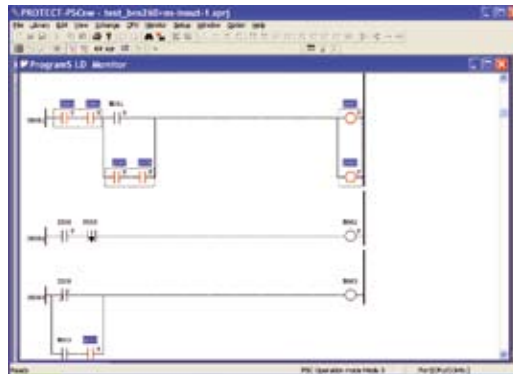

Fig. 10: Online visualisation: active contacts are displayed in colour

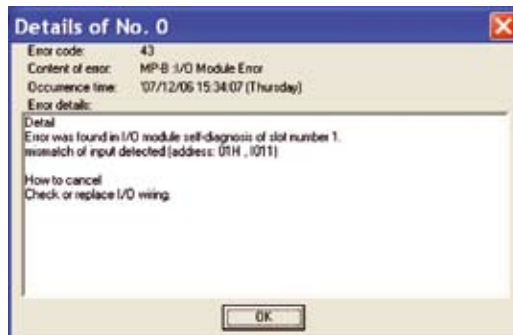
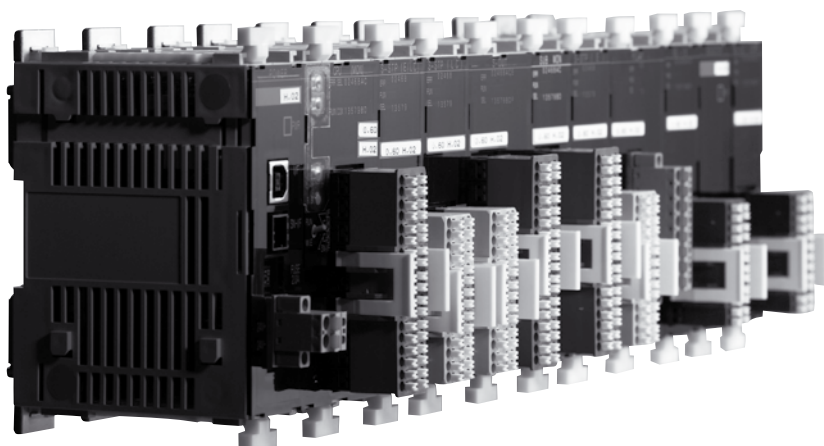

Fig. 11: Diagnosis: clear problem solutions are provided in the event of an internal or external error



able Modular Safety System

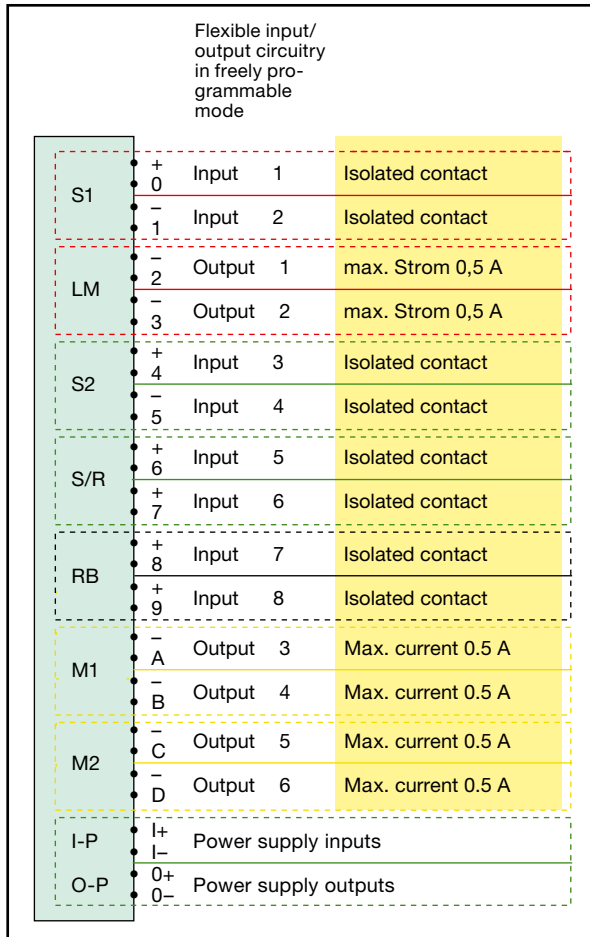

Fig. 12: External circuitry Mode 3 (freely programmable mode)

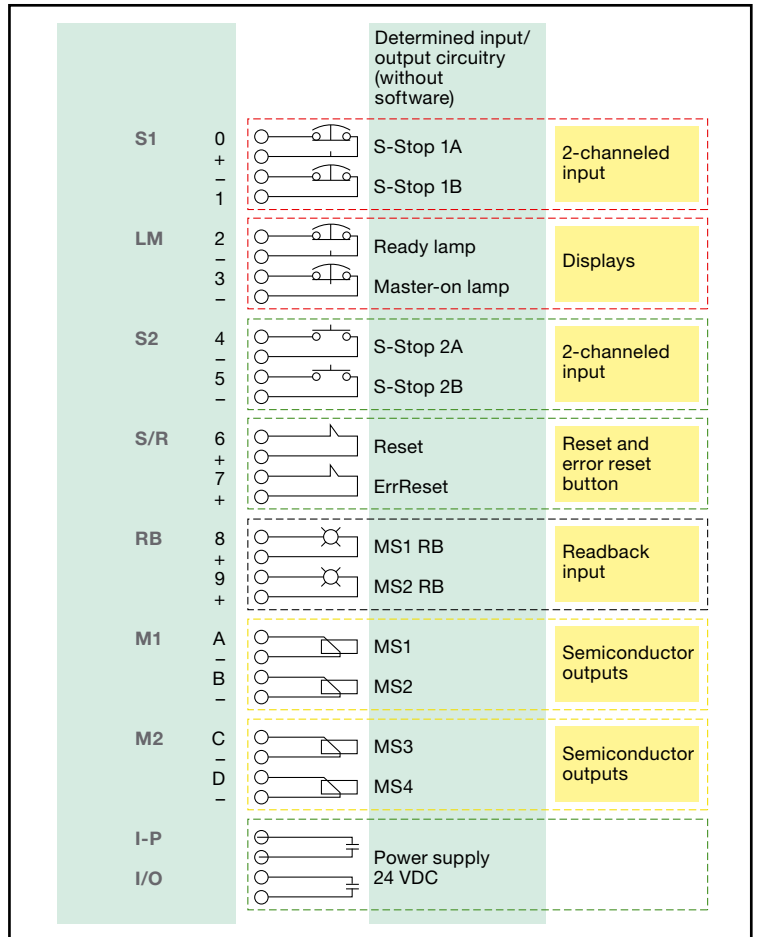

Fig. 13: Example of external wiring

Terminal assignment

In general two different options for terminal assignment are available depending on operating mode. The freely programmable operating mode offers the user the greatest possible flexibility. All input signals can be freely connected to each other and outputs can be activated with the desired mutual dependence (Fig. 12).

By contrast the terminal connection in operating mode 1 has a completely different design in which it is possible to achieve a zone section shut-down entirely without software programming. In a similar way to safety relay module circuitry, here the user is given exact specifications for how the terminal assignment of the input and output signals should look (Fig. 13).



Order address and Centre of Competence:



Elan Schaltelemente GmbH & Co. KG

Im Ostpark 2
D-35435 Wettenberg
P.O. Box 1109
D-35429 Wettenberg

Phone: +49 (0)641 9848-0
Facsimile: +49 (0)641 9848-420
E-Mail: info@elan.schmersal.de
Internet: www.elan.de